







MAXPOWER CS6U- 315|320|325|330P

Canadian Solar's modules use the latest innovative cell technology, increasing module power output and system reliability, ensured by 15 years of experience in module manufacturing, well-engineered module design, stringent BOM quality testing, an automated manufacturing process and 100% EL testing.

KEY FEATURES

-  Excellent module efficiency of up to 16.97 %
-  Outstanding low irradiance performance of up to 96.0 %
-  High PTC rating of up to 91.55 %
-  IP67 junction box for long-term weather endurance
-  Heavy snow load up to 5400 Pa, wind load up to 2400 Pa

25 years linear power output warranty

10 years product warranty on materials and workmanship

Management System Certificates*

- ISO 9001:2008 / Quality management system
- ISO 14001:2004 / Standards for environmental management system
- OHSAS 18001:2007 / International standards for occupational health & safety

Product CERTIFICATES*

- IEC 61215 / IEC 61730: VDE / CE / CQC / MCS / INMETRO
- UL 1703 / IEC 61215 performance: CEC listed (US)
- UL 1703: CSA / IEC 61701 ED2: VDE / IEC 62716: VDE
- UNI 9177 Reaction to Fire: Class 1
- IEC60068-2-68: SGS
- Take-e-way



* As there are different certification requirements in different markets, please contact your local Canadian Solar sales representative for the specific certificates applicable to the products in the region in which the products are to be used.

CANADIAN SOLAR INC. is committed to providing high quality solar products, solar system solutions and services to customers around the world. As a leading PV project developer and manufacturer of solar modules with over 16 GW deployed around the world since 2001, Canadian Solar Inc. (NASDAQ: CSIQ) is one of the most bankable solar companies worldwide.

ENGINEERING DRAWING (mm)

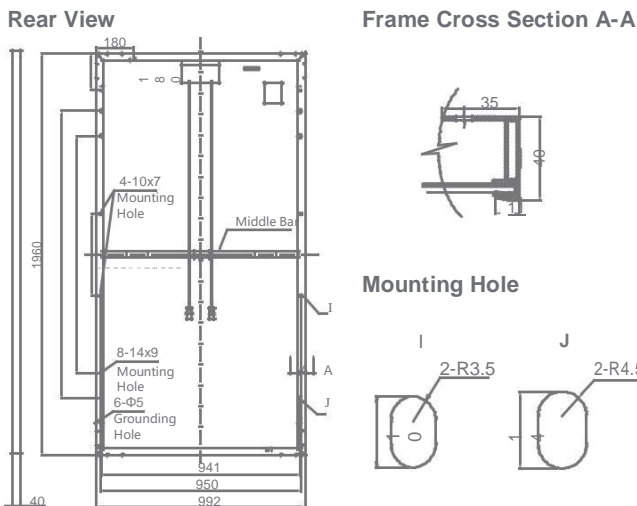

CS6U-320P / I-V CURVES

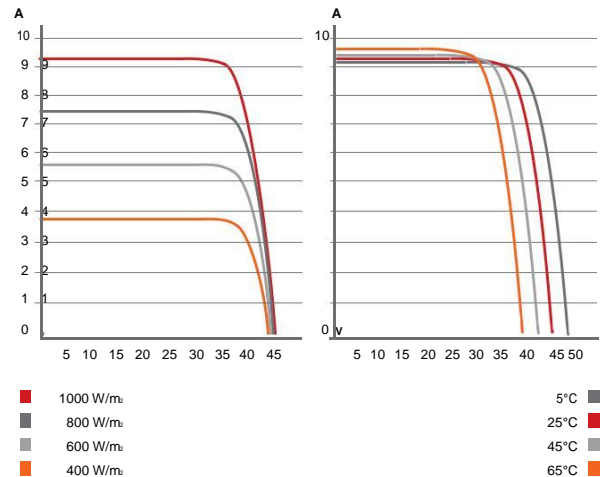

Electrical Data | STC*

CS6U	315P	320P	325P	330P
Nominal Max. Power (Pmax)	315 W	320 W	325 W	330 W
Opt. Operating Voltage (Vmp)	36.6 V	36.8 V	37.0 V	37.2 V
Opt. Operating Current (Imp)	8.61 A	8.69 A	8.78 A	8.88 A
Open Circuit Voltage (Voc)	45.1 V	45.3 V	45.5 V	45.6 V
Short Circuit Current (Isc)	9.18 A	9.26 A	9.34 A	9.45 A
Module Efficiency	16.20%	16.46%	16.72%	16.97%
Operating Temperature	-40°C ~ +85°C			
Max. System Voltage	1000 V (IEC) or 1000 V (UL)			
Module Fire Performance	TYPE 1 (UL 1703) or CLASS C (IEC 61730)			
Max. Series Fuse Rating	15 A			
Application Classification	Class A			
Power Tolerance	0 ~ + 5 W			

* Under Standard Test Conditions (STC) of irradiance of 1000 W/m², spectrum AM 1.5 and cell temperature of 25°C.

Electrical Data | Noct*

CS6U	315P	320P	325P	330P
Nominal Max. Power (Pmax)	228 W	232 W	236 W	239 W
Opt. Operating Voltage (Vmp)	33.4 V	33.6 V	33.7 V	33.9 V
Opt. Operating Current (Imp)	6.84 A	6.91 A	6.98 A	7.05 A
Open Circuit Voltage (Voc)	41.5 V	41.6 V	41.8 V	41.9 V
Short Circuit Current (Isc)	7.44 A	7.50 A	7.57 A	7.66 A

* Under Nominal Operating Cell Temperature (NOCT), irradiance of 800 W/m², spectrum AM 1.5, ambient temperature 20°C, wind speed 1 m/s.

PERFORMANCE AT LOW IRRADIANCE

Outstanding performance at low irradiance, with an average relative efficiency of 96.0 % from irradiances, between 1000 W/m² and 200 W/m² (AM 1.5, 25°C).

The specification and key features described in this datasheet may deviate slightly and are not guaranteed. Due to on-going innovation, research and product enhancement, Canadian Solar Inc. reserves the right to make any adjustment to the information described herein at any time without notice. Please always obtain the most recent version of the datasheet which shall be duly incorporated into the binding contract made by the parties governing all transactions related to the purchase and sale of the products described herein.

Caution: For professional use only. The installation and handling of PV modules requires professional skills and should only be performed by qualified professionals. Please read the safety and installation instructions before using the modules.

mechanical Data

Specification	Data
Cell Type	Poly-crystalline, 6 inch
Cell Arrangement	72 (6 × 12)
Dimensions	1960 × 992 × 40 mm (77.2 × 39.1 × 1.57 in)
Weight	22.4 kg (49.4 lbs)
Front Cover	3.2 mm tempered glass
Frame Material	Anodized aluminium alloy
J-Box	IP67, 3 diodes
Cable	4 mm ² (IEC) or 4 mm ² & 12 AWG 1000V (UL), 1160 mm (45.7 in)
Connector	T4 series or PV2 series
Per Pallet	26 pieces, 635 kg (1400 lbs)
Per container (40' HQ)	624 pieces

temperature characteristics

Specification	Data
Temperature Coefficient (Pmax)	-0.41 % / °C
Temperature Coefficient (Voc)	-0.31 % / °C
Temperature Coefficient (Isc)	0.053 % / °C
Nominal Operating Cell Temperature	45±2 °C

Partner section

Sold in India by:

Aviraj Urja

Call: +91-9711461061

Email: info@avirajurja.com

Web: www.avirajurja.com